



2" - 36" MECHANICAL JOINT - DUCTILE IRON FULL BODY FITTINGS

Manufactured in Accordance With
ANSI/AWWA C-110/A21.10 and ANSI/AWWA C111/A21.11 Standard
Full Body Mechanical Joint Fittings

BENDS

90° Bends (1/4)

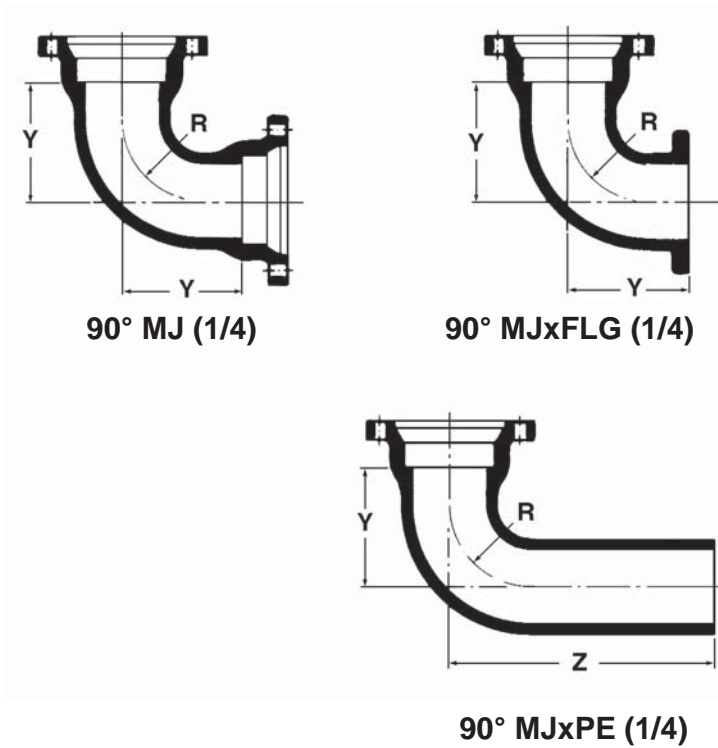

Size	All Dimensions in Inches			Weight lbs.		
	R	Y	Z	MJ	MJxPE*	MJxFLG
*2	2.25	3.25	...	14
3	4.0	5.5	13.5	35	35	...
4	4.5	6.5	14.5	55	50	39
6	6.0	8.0	16.0	85	80	75
8	7.0	9.0	17.0	125	120	115
10	9.0	11.0	19.0	190	190	165
12	10.0	12.0	20.0	255	255	...
14	11.5	14.0	22.0	380	365	...
16	12.5	15.0	23.0	490	470	415
18	14.0	16.5	24.5	625	600	520
20	15.5	18.0	26.0	790	775	...
24	18.5	22.0	30.0	1215	1175	1150
30	21.5	25.0	33.0	2030	1585	...
36	24.5	28.0	36.0	2475

45° Bends (1/8)

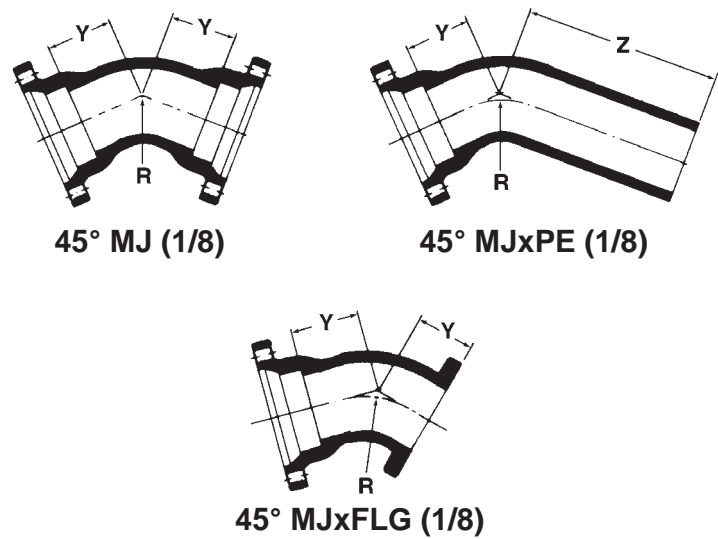

Size	All Dimensions in Inches			Weight lbs.		
	R	Y	Z	MJ	MJxFLG*	MJxPE
*2	1.96	1.8	...	13
3	3.62	3.0	11.0	30
4	4.81	4.0	12.0	50	42	45
6	7.25	5.0	13.0	75	60	70
8	8.44	5.5	13.5	110	105	105
10	10.88	6.5	14.5	155	135	155
12	13.25	7.5	15.5	215	200	215
14	12.06	7.5	15.5	300	...	280
16	13.25	8.0	16.0	380	360	360
18	14.50	8.5	16.5	470	422	455
20	16.88	9.5	17.5	595	500	565
24	18.12	11.0	19.0	865	800	825
30	27.75	15.0	23.0	1620	...	1275
36	35.00	18.0	26.0	2095

* Not included in AWWA C110

2" - 36" MECHANICAL JOINT - DUCTILE IRON FULL BODY FITTINGS

Manufactured in Accordance With
ANSI/AWWA C-110/A21.10 and ANSI/AWWA C111/A21.11 Standard
Full Body Mechanical Joint Fittings

BENDS

22 1/2° Bends (1/16)

Size	All Dimensions in Inches			Weight lbs.		
	R	Y	Z	MJ	MJxFLG*	MJxPE
3	7.56	3.0	11.0	30
4	10.06	4.0	12.0	50	...	45
6	15.06	5.0	13.0	75	60	70
8	17.62	5.5	13.5	110	105	105
10	22.62	6.5	14.5	160	155	160
12	27.62	7.5	15.5	220	200	220
14	25.12	7.5	15.5	300	...	285
16	27.62	8.0	16.0	385	315	365
18	30.19	8.5	16.5	480	422	455
20	35.19	9.5	17.5	605	...	575
24	37.69	11.0	19.0	880	800	725
30	57.81	15.0	23.0	1650	...	1295

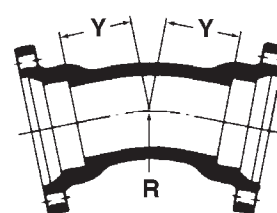

22 1/2° MJ (1/16)

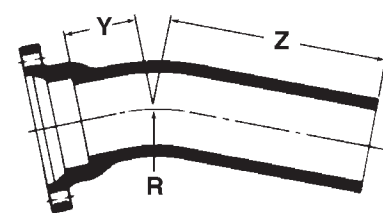

22 1/2° MJxPE (1/16)

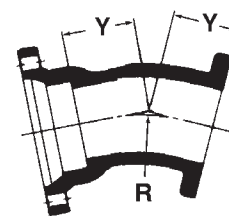

22 1/2° MJxFLG (1/16)

11 1/4° Bends (1/32)

Size	All Dimensions in Inches			Weight lbs.		
	R	Y	Z	MJ	MJxFLG*	MJxPE
3	15.25	3.0	11.0	30
4	20.31	4.0	12.0	50
6	30.50	5.0	13.0	75	69	70
8	35.50	5.5	13.5	110	105	105
10	45.69	6.5	14.5	160	...	160
12	55.81	7.5	15.5	220	215	220
14	50.75	7.5	15.5	305	...	285
16	55.81	8.0	16.0	385	300	365
18	60.94	8.5	16.5	480	390	455
20	71.06	9.5	17.5	610	...	575
24	76.12	11.0	19.0	885	800	845
30	116.75	15.0	23.0	1410	...	1305
36	147.25	18.0	26.0	2145

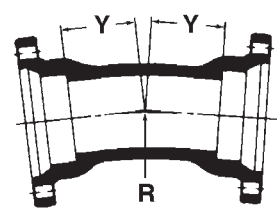

11 1/4° MJ (1/32)

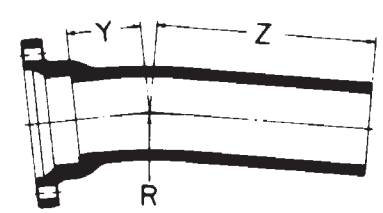

11 1/4° MJxPE (1/32)

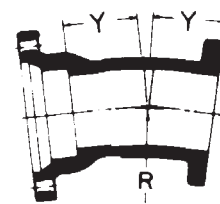

11 1/4° MJxFLG (1/32)

* Not included in AWWA C110



2" - 36" MECHANICAL JOINT - DUCTILE IRON FULL BODY FITTINGS

Manufactured in Accordance With
ANSI/AWWA C-110/A21.10 and ANSI/AWWA C111/A21.11 Standard
Full Body Mechanical Joint Fittings

TEES

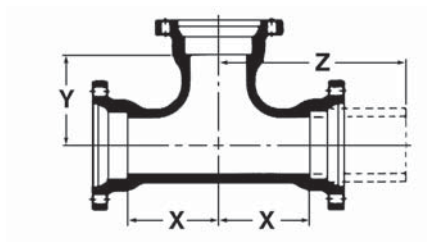

**Straight Tees and
Reducing on Branch Tees**

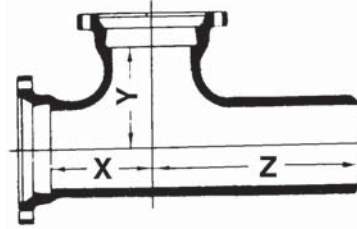

MJxMJxPE

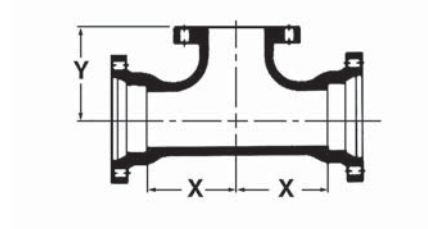

**Bullhead
(available in MJ or Flange only)**

Size		Dimensions			Weights		
Run	Branch	X	Y	Z	MJ	**MJxPExMJ	**MJxMJxFLG
*2	2	3.25	3.25	...	22
*3	2	3.25	3.25	...	43
3	3	5.5	5.5	13.5	55
*4	2	4.8	4.8	14.5	57	...	53
4	3	6.5	6.5	14.5	76
4	4	6.5	6.5	14.5	80	75	74
4	6	8.0	8.0	...	95
*6	2	8.0	8.0	...	78
6	3	8.0	8.0	16.0	110
6	4	8.0	8.0	16.0	115	110	109
6	6	8.0	8.0	16.0	125	120	115
6	8	9.0	9.0	...	175
8	3	9.0	9.0	17.0	155
8	4	9.0	9.0	17.0	165	160	159
8	6	9.0	9.0	17.0	175	170	165
8	8	9.0	9.0	17.0	185	180	175
10	4	11.0	11.0	19.0	235	235	229
10	6	11.0	11.0	19.0	250	250	237
10	8	11.0	11.0	19.0	260	260	250
10	10	11.0	11.0	19.0	310	250	300

Notice: Weights published in this catalog are for shipping purpose only. Actual weights may vary because some fittings are produced in different foundries. All fittings are made in the USA and meet the AWWA standards to which they are designed.

* These items normally are made only as ordered.



**2" - 36" MECHANICAL JOINT - DUCTILE IRON
FULL BODY FITTINGS**

Manufactured in Accordance With
ANSI/AWWA C-110/A21.10 and ANSI/AWWA C111/A21.11 Standard
Full Body Mechanical Joint Fittings

TEES (CON'T)

Size		Dimensions			Weights		
Run	Branch	X	Y	Z	MJ	**MJxPExMJ	**MJxMJxFLG
12	4	12.0	12.0	20.0	315	315	309
12	6	12.0	12.0	20.0	325	325	315
12	8	12.0	12.0	20.0	340	240	330
12	10	12.0	12.0	20.0	390	390	385
12	12	12.0	12.0	20.0	410	410	400
14	6	14.0	14.0	22.0	485	470	...
14	8	14.0	14.0	22.0	500	480	...
14	10	14.0	14.0	22.0	515	500	...
14	12	14.0	14.0	22.0	540	525	...
14	14	14.0	14.0	22.0	585	570	...
*16	4	15.0	15.0	23.0	600	580	605
16	6	15.0	15.0	23.0	615	590	605
16	8	15.0	15.0	23.0	625	605	615
16	10	15.0	15.0	23.0	645	620	...
16	12	15.0	15.0	23.0	660	640	650
16	14	15.0	15.0	23.0	710	690	...
16	16	15.0	15.0	23.0	740	720	730
18	6	13.0	15.5	21.0	670	645	665
18	8	13.0	15.5	21.0	685	655	675
18	10	13.0	15.5	21.0	700	670	...
18	12	13.0	15.5	21.0	715	690	705
18	14	16.5	16.5	24.5	865	840	...
18	16	16.5	16.5	24.5	905	880	...
18	18	16.5	16.5	24.5	945	920	915
20	6	14.0	17.0	22.0	830	800	...
20	8	14.0	17.0	22.0	845	810	835
20	10	14.0	17.0	22.0	860	825	...
20	12	14.0	17.0	22.0	875	840	...
20	14	14.0	17.0	22.0	910	875	...
20	16	18.0	18.0	26.0	1095	1060	...
20	18	18.0	18.0	26.0	1140	1110	...
20	20	18.0	18.0	26.0	1185	1155	1165
24	6	15.0	19.0	23.0	1145	1105	1125
24	8	15.0	19.0	23.0	1160	1115	1140
24	10	15.0	19.0	23.0	1170	1130	...
24	12	15.0	19.0	23.0	1185	1145	1165
24	14	15.0	19.0	23.0	1220	1180	...
24	16	15.0	19.0	23.0	1245	1200	...
24	18	22.0	22.0	30.0	1660	1615	...
24	20	22.0	22.0	30.0	1720	1680	...
24	24	22.0	22.0	30.0	1815	1775	1795



**2" - 36" MECHANICAL JOINT - DUCTILE IRON
FULL BODY FITTINGS**

Manufactured in Accordance With
ANSI/AWWA C-110/A21.10 and ANSI/AWWA C111/A21.11 Standard
Full Body Mechanical Joint Fittings

TEES (CON'T)

Size		Dimensions			Weights		
Run	Branch	X	Y	Z	MJ	**MJxPExMJ	**MJxMJxFLG
30	6	18.0	23.0	26.0	1730	1615	...
30	8	18.0	23.0	26.0	1745	1630	...
30	10	18.0	23.0	26.0	1760	1645	...
30	12	18.0	23.0	26.0	1780	1665	...
30	14	18.0	23.0	26.0	1800	1685	...
30	16	18.0	23.0	26.0	1954	1705	...
30	18	18.0	23.0	26.0	1845	1730	...
30	20	18.0	23.0	26.0	1875	1760	...
30	24	25.0	25.0	33.0	2400	2280	...
30	30	25.0	25.0	33.0	2595	1480	3080
36	6	20.0	26.0	28.0	2439	...	2430
36	8	20.0	26.0	28.0	2520
36	10	20.0	26.0	28.0	2535
36	12	20.0	26.0	28.0	2550	...	2550
36	14	20.0	26.0	28.0	2570
36	16	20.0	26.0	28.0	2585	...	2450
36	18	20.0	26.0	28.0	2610
36	20	20.0	26.0	28.0	2635
36	24	20.0	26.0	28.0	2792	...	2660
36	30	28.0	28.0	36.0	3545
36	36	28.0	28.0	36.0	3982

** Made to order only. Not Returnable

2" - 36" MECHANICAL JOINT - DUCTILE IRON FULL BODY FITTINGS

ANSI/AWWA-C110/A21.10 and ANSI/AWWA-C111/A21.11 Standards

CROSSES

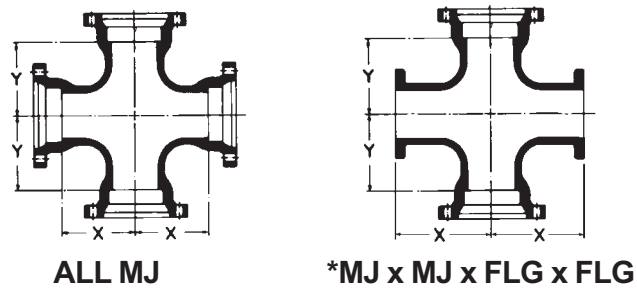

ALL MJ

*MJ x MJ x FLG x FLG

ADAPTERS

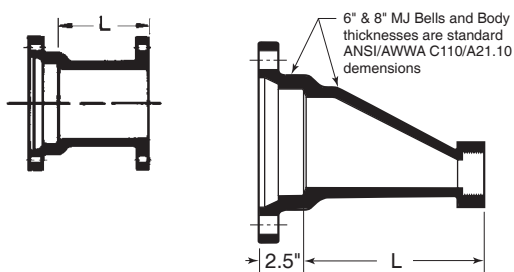

MJ x FLG

MJ x FIPT ECCENTRIC REDUCER

Dimensions			Dimensions		
Size	L	Weights	Size	L	Weights
3	8	30	30	10	840
4	8	40	6x2	13	51
6	8	60	8x2	15	71
8	8	85			
10	8	115			
12	8	155			
14	8	250			
16	8	260			
18	8	305			
20	8	365			
24	8	495			

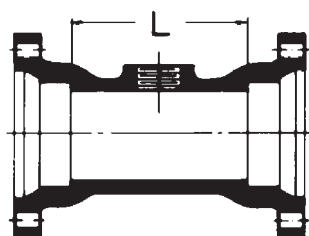

MJ TAPPED TEE
MJ Tapped Tee (2" Tap)

Size	Dimensions		Weights
	L	Max. Tap	
3	8"	2"	35
4	8"	2"	45
6	8"	2"	70
8	8"	2"	95
10	8"	2"	130
12	8"	2"	165

*Check with CLOW for availability on these items

Size		Dimensions		Weights	
Run	Branch	X	Y	MJ	*MJxFLG
4	3	6.5	6.5	90	70
4	4	6.5	6.5	105	100
6	6	8.0	8.0	160	120
8	4	9.0	9.0	185	180
8	6	9.0	9.0	205	180
8	8	9.0	9.0	235	215
10	4	11.0	11.0	260	260
10	6	11.0	11.0	285	285
10	8	11.0	11.0	310	310
10	10	11.0	11.0	380	330
12	4	12.0	12.0	340	315
12	6	12.0	12.0	360	340
12	8	12.0	12.0	385	365
12	10	12.0	12.0	460	...
12	12	12.0	12.0	495	487
12	4	12.0	12.0	340	340
12	6	12.0	12.0	360	325
14	4	12.0	12.0	450	...
14	6	14.0	14.0	485	470
14	8	14.0	14.0	500	...
14	10	14.0	14.0	515	...
14	12	14.0	16.0	540	...
14	14	14.0	16.0	585	...
16	4	15.0	15.0	575	555
16	6	15.0	15.0	650	630
16	8	15.0	15.0	675	655
16	10	15.0	15.0	645	...
16	12	15.0	15.0	688	...
16	14	15.0	15.0	710	690
16	16	15.0	15.0	895	875
18	6	13.0	15.5	705	680
18	8	13.0	15.5	730	...
18	10	13.0	15.5	760	...
18	12	13.0	15.5	790	...
18	14	16.5	16.5	990	965
18	16	16.5	16.5	1060	1035
18	18	16.5	16.5	1130	...
20	6	14.0	17.0	865	...
20	8	14.0	17.0	845	...
20	10	14.0	17.0	920	890
20	12	14.0	17.0	955	...
20	14	14.0	17.0	1025	990
20	16	18.0	18.0	1245	...
20	18	18.0	18.0	1155	1120
20	20	18.0	18.0	1415	...
24	6	15.0	19.0	1180	...
24	8	15.0	19.0	1200	...
24	10	15.0	19.0	1170	...
24	12	15.0	19.0	1260	...
24	14	15.0	19.0	1325	1285
24	16	15.0	19.0	1375	...
24	18	22.0	22.0	1865	1820
24	20	22.0	22.0	1965	...
24	24	22.0	22.0	2155	...
30	6	18.0	23.0	2085	...
30	8	18.0	23.0	1795	1680
30	10	18.0	23.0	1830	1715
30	12	18.0	23.0	2165	...
30	14	18.0	23.0	1905	1790
30	16	18.0	23.0	1950	1835
30	18	18.0	23.0	2000	1885
30	20	18.0	23.0	2060	1945
30	24	25.0	25.0	3180	...
30	30	25.0	25.0	3640	...
36	36	28.0	28.0	4370	...



2" - 36" MECHANICAL JOINT - DUCTILE IRON FULL BODY FITTINGS

Manufactured in Accordance With
ANSI/AWWA C-110/A21.10 and ANSI/AWWA C111/A21.11 Standard
Full Body Mechanical Joint Fittings

CROSSES
For Use With
Push-on Pipe,
Mechanical Joint Pipe
Or
Any Plain End Pipe of
Same Outside Diameter

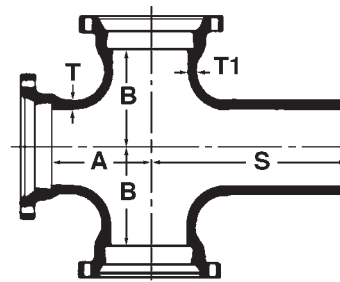

DIMENSIONS AND WEIGHTS

Nominal Diameter Inches		Pressure Rating psi	Dimensions Inches					Approximate Weight Pounds
Run	Branch		Ductile	T	TI	A	B	S
4	4	350	.52	.52	6.5	6.5	14.5	100
6	4	350	.55	.52	8.0	8.0	16.0	135
6	6	350	.55	.55	8.0	8.0	16.0	155
8	4	350	.60	.52	9.0	9.0	17.0	180
8	6	350	.60	.55	9.0	9.0	17.0	200
8	8	350	.60	.60	9.0	9.0	17.0	230
10	4	350	.68	.52	11.0	11.0	19.0	260
10	6	350	.68	.55	11.0	11.0	19.0	285
10	8	350	.68	.60	11.0	11.0	19.0	310
10	10	350	.80	.80	11.0	11.0	19.0	380
12	4	350	.75	.52	12.0	12.0	20.0	340
12	6	350	.75	.55	12.0	12.0	20.0	360
12	8	350	.75	.60	12.0	12.0	20.0	385
12	10	350	.87	.80	12.0	12.0	20.0	460
12	12	350	.87	.87	12.0	12.0	20.0	495
14	4	350	.66	.55	12.0	12.0	22.0	445
14	6	350	.66	.55	14.0	14.0	22.0	460
14	8	350	.66	.60	14.0	14.0	22.0	485
14	10	350	.66	.68	14.0	14.0	22.0	525
14	12	350	.82	.75	14.0	14.0	22.0	615
14	14	350	.82	.82	14.0	14.0	22.0	695
16	4	350	.70	.55	15.0	14.0	23.0	540
16	6	350	.70	.55	15.0	15.0	23.0	555
16	8	350	.70	.60	15.0	15.0	23.0	585
16	10	350	.70	.68	15.0	15.0	23.0	625
16	12	350	.70	.75	15.0	15.0	23.0	665
16	14	350	.89	.82	15.0	15.0	23.0	810
16	16	350	.89	.89	15.0	15.0	23.0	875

2" - 36" MECHANICAL JOINT - DUCTILE IRON FULL BODY FITTINGS

Manufactured in Accordance With
ANSI/AWWA C-110/A21.10 and ANSI/AWWA C111/A21.11 Standard
Full Body Mechanical Joint Fittings

CROSSES (CON'T)

CROSSES
For Use With
Push-on Pipe,
Mechanical Joint Pipe
Or
Any Plain End Pipe of
Same Outside Diameter

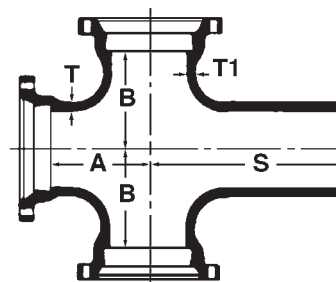

Cross
MJ, PE, MJ and MJ

DIMENSIONS AND WEIGHTS

Nominal Diameter Inches		Pressure Rating psi	Dimensions Inches					Approximate Weight Pounds and Body Casting Only
Run	Branch	Ductile	T	T1	A	B	S	MJ, PE, MJ and MJ
18	6	350	.75	.55	13.0	15.5	21.0	600
18	8	350	.75	.60	13.0	15.5	21.0	630
18	10	350	.75	.68	13.0	15.5	21.0	660
18	12	350	.75	.75	13.0	15.5	21.0	700
18	14	350	.75	.66	16.5	16.5	24.5	845
18	16	350	.75	.70	16.5	16.5	24.5	905
18	18	350	.75	.75	16.5	16.5	24.5	965
20	6	350	.80	.55	14.0	17.0	22.0	730
20	8	350	.80	.60	14.0	17.0	22.0	760
20	10	350	.80	.68	14.0	17.0	22.0	790
20	12	350	.80	.75	14.0	17.0	22.0	830
20	14	350	.80	.66	14.0	17.0	22.0	875
20	16	350	.80	.70	18.0	18.0	26.0	1055
20	18	350	.80	.75	18.0	18.0	26.0	1120
20	20	350	.80	.80	18.0	18.0	26.0	1200
24	6	350	.89	.55	15.0	19.0	23.0	985
24	8	350	.89	.60	15.0	19.0	23.0	1005
24	10	350	.89	.68	15.0	19.0	23.0	1045
24	12	350	.89	.75	15.0	19.0	23.0	1070
24	14	350	.89	.66	15.0	19.0	23.0	1115
24	16	350	.89	.70	15.0	19.0	23.0	1160
24	18	350	.89	.75	22.0	22.0	30.0	1550
24	20	350	.89	.80	22.0	22.0	30.0	1630
24	24	350	.89	.89	22.0	22.0	30.0	1795
30	12	250	1.03	.75	18.0	23.0	26.0	1750
30	14	250	1.03	.66	18.0	23.0	26.0	1790
30	16	250	1.03	.70	18.0	23.0	26.0	1835
30	18	250	1.03	.75	18.0	23.0	26.0	1885
30	20	250	1.03	.80	18.0	23.0	26.0	1945
30	24	250	1.03	.89	25.0	25.0	33.0	2560
30	30	250	1.03	1.03	25.0	25.0	33.0	2955



2" - 36" MECHANICAL JOINT - DUCTILE IRON FULL BODY FITTINGS

ANSI/AWWA-C110/A21.10 and ANSI/AWWA-C111/A21.11 Standards

Reducers

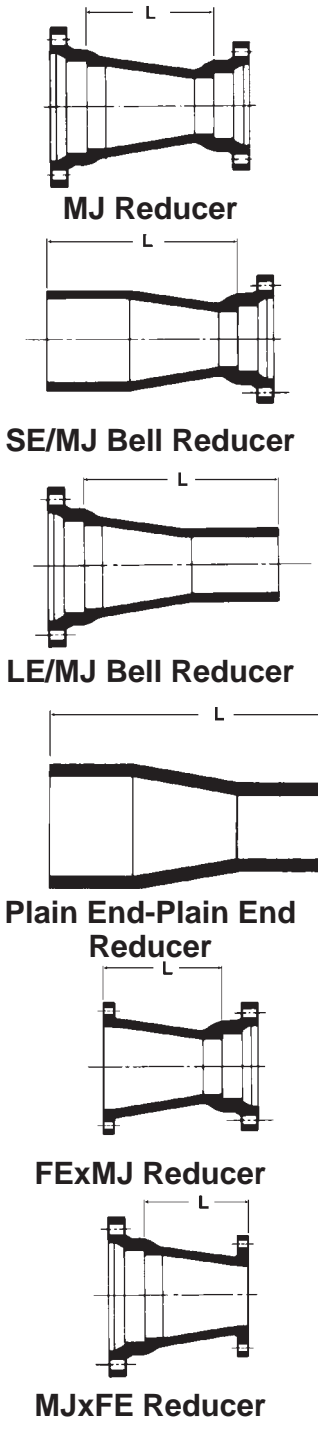

Size	Laying Lengths (L)						Weights					
	MJ	MJ-SEB	MJ-LEB	PExPE	FExMJ	MJxFE	MJ	MJ-SEB	MJ-LEB	PExPE	FExMJ	MJxFE
*3x2	6	14	14	20	25	25	20
*4x2	7	15	15	25	30	30	30
4x3	7	15	15	23	7	7	40	34	40	35	34	33
*6x2	9	17	17	25	45	45	45
6x3	9	17	17	25	...	9	55	50	50	46
6x4	9	17	17	25	9	9	60	60	60	55	52	54
8x3	11	19	19	27	75	70	70
8x4	11	19	19	27	11	11	80	80	80	75	75	72
8x6	11	19	19	27	11	11	95	90	90	85	80	77
10x4	12	20	20	28	105	100	100	100
10x6	12	20	20	28	12	12	115	115	115	115	114	105
10x8	12	20	20	28	12	12	135	130	130	130	145	115
12x4	14	22	22	30	135	130	130	130
12x6	14	22	22	30	14	12	150	150	145	145	125	145
12x8	14	22	22	30	14	12	165	165	165	165	165	165
12x10	14	22	22	30	14	12	190	190	185	185	190	185
14x6	16	24	24	32	200	185	200	185	...	195
14x8	16	24	24	32	220	205	220	205	...	215
14x10	16	24	24	32	245	230	245	215
14x12	16	24	24	32	270	255	275	260	...	270
16x6	18	26	26	34	250	230	250	230
16x8	18	26	26	34	270	350	270	250
16x10	18	26	26	34	300	280	300	280
16x12	18	26	26	34	18	18	325	305	330	310	305	315
16x14	18	26	26	34	370	350	355	335
18x8	19	27	27	35	...	19	320	295	320	295	...	290
18x10	19	27	27	35	350	325	350	325
18x12	19	27	27	35	...	19	380	355	440	360	...	360
18x14	19	27	27	35	425	400	410	385
18x16	19	27	27	35	...	19	465	440	445	420	...	385
20x10	20	28	28	36	410	380	410	380
20x12	20	28	28	36	440	410	445	415
20x14	20	28	28	36	485	455	480	440
20x16	20	28	28	36	...	20	530	500	510	475	...	510
20x18	20	28	28	36	575	545	550	520
24x10	24	565
24x12	24	32	32	40	...	24	610	570	615	575	...	455
24x14	24	32	32	40	660	620	645	605
24x16	24	32	32	40	705	665	685	645
24x18	24	32	32	40	760	720	735	695
24x20	24	32	32	40	815	775	785	745
30x12	30	38	38	46	920	800	930	807
30x14	30	38	38	46	940	825	925	804
*30x16	30	38	38	46	1150	1040	938	1015
30x18	30	38	38	46	1160	1050	965	1025
30x20	30	38	38	46	1225	1120	1020	1090
30x24	30	38	38	46	1360	1255	1320	1215
36x20	36	...	44	1495	...	1466
36x24	36	...	44	52	1580	...	1535	1389
30x30	36	44	...	52	1919	1721	...	1585

* Not included in AWWA C110

2" - 36" MECHANICAL JOINT - DUCTILE IRON FULL BODY FITTINGS

ANSI/AWWA-C110/A21.10 and ANSI/AWWA-C111/A21.11 Standards
SOLID SLEEVES

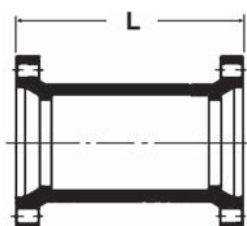

Standard

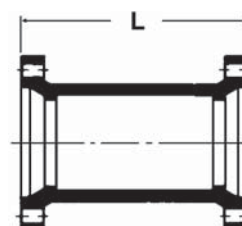

*Dual Purpose†

Size	Pipe O.D.	Short		Long	
		L	Weight	L	Weight
*2	2.50	8.0	12	...	18
3	3.96	7.5	25	12	30
4	4.80	7.5	35	12	45
6	6.90	7.5	45	12	65
8	9.05	7.5	65	12	85
10	11.10	7.5	85	12	115
12	13.20	7.5	110	12	145
14	15.30	9.5	165	15	225
16	17.40	9.5	200	15	275
18	19.50	9.5	240	15	330
20	21.60	9.5	275	15	380
24	25.80	9.5	360	15	505
30	32.00	15.0	745	24	1085
36	38.30	24	1502

*Not included in AWWA C110

Size	Pipe O.D.	Short		Long	
		L	Weight	L	Weight
4	4.80/5.00	7.5	35	12	45
6	6.90/7.10	7.5	45	12	65
8	9.05/9.30	7.5	65	12	85
10	11.10/11.40	12	115
12	13.20/13.50	12	235
16	17.40/17.80	15	385

†Uses MJ Dual Purpose Gland

*Not included in AWWA C110

*MJ x PE DUAL-PURPOSE CUTTING-IN SLEEVE

With Dual-Purpose Accessories

(NOTE: Gland with cup-joint set screws available at extra cost when specified. NOT FOR RESTRAINT.)



Cutting-In Sleeve & Gland

Size	For Use On Pipe O.D.	L	Li	D	Weights	
					Gland Only	Gland & Sleeve
4	4.80 - 5.00	12	8	4.80	9.5	72
6	6.90 - 7.10	12	8	6.90	13.0	98
8	9.05 - 9.30	12	8	9.05	20.0	136
10	11.10 - 11.40	12	8	11.10	25.0	175
12	13.20 - 13.50	12	8	13.20	30.0	235

*Not included in AWWA C110



2" - 36" MECHANICAL JOINT - DUCTILE IRON FULL BODY FITTINGS

ANSI/AWWA-C110/A21.10 and ANSI/AWWA-C111/A21.11 Standards
Full Body Mechanical Joint Fittings

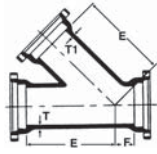

**"Y" Branch
MJ, MJ and MJ**

"Y" BRANCHES
For Use With Push-on Pipe,
Mechanical Joint Pipe Or
Any Plain End Pipe of
Same Outside Diameter

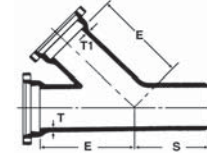

**"Y" Branch
MJ, PE and MJ**

DIMENSIONS AND WEIGHTS

Nominal Diameter Inches		Pressure Rating psi	Dimensions Inches					Approximate Weight Pounds Body Casting Only	
Run	Branch		Ductile	T	T1	E	F	S	MJ, MJ and MJ
3	3	350	.48	.48	10.0	3.0	11.0	60	...
4	3	350	.52	.48	12.0	3.0	11.0	80	...
4	4	350	.52	.52	12.0	3.0	11.0	90	85
6	3	350	.55	.48	14.5	3.5	11.5	120	...
6	4	350	.55	.52	14.5	3.5	11.5	130	125
6	6	350	.55	.55	14.5	3.5	11.5	145	140
8	4	350	.60	.52	17.5	4.5	12.5	190	185
8	6	350	.60	.55	17.5	4.5	12.5	208	200
8	8	350	.60	.60	17.5	4.5	12.5	230	225
10	4	350	.68	.52	20.5	5.0	13.0	270	270
10	6	350	.68	.55	20.5	5.0	13.0	335	285
10	8	350	.68	.60	20.5	5.0	13.0	310	310
10	10	350	.68	.68	20.5	5.0	13.0	435	340
12	4	350	.75	.52	24.5	5.5	13.5	380	380
12	6	350	.75	.55	24.5	5.5	13.5	400	400
12	8	350	.75	.60	24.5	5.5	13.5	505	425
12	10	350	.75	.68	24.5	5.5	13.5	450	450
12	12	350	.75	.75	24.5	5.5	13.5	626	490
14	6	250	.82	.55	27.0	6.0	14.0	570	555
14	8	250	.82	.60	27.0	6.0	14.0	595	580
14	10	250	.82	.68	27.0	6.0	14.0	625	610
14	12	250	.82	.75	27.0	6.0	14.0	670	655
14	14	250	.82	.82	27.0	6.0	14.0	730	715
16	6	250	.89	.55	30.0	6.5	14.5	735	715
16	8	250	.89	.60	30.0	6.5	14.5	760	740
16	10	250	.89	.68	30.0	6.5	14.5	800	780
16	12	250	.89	.75	30.0	6.5	14.5	835	815
16	14	250	.89	.82	30.0	6.5	14.5	900	880
16	16	250	.89	.89	30.0	6.5	14.5	1079	940
18	8	250	.96	.60	25.0	1.0	9.0	700	675
18	10	250	.96	.68	32.0	7.0	15.0	975	950
18	12	250	.96	.75	32.0	7.0	15.0	1015	990
18	14	250	.96	.82	32.0	7.0	15.0	1075	1050
18	16	250	.96	.89	32.0	7.0	15.0	1135	1110
18	18	250	.96	.96	32.0	7.0	15.0	1200	1175
20	8	250	1.03	.60	27.0	1.0	9.0	855	825
20	10	250	1.03	.66	27.0	1.0	9.0	885	855
20	12	250	1.03	.75	35.0	8.0	16.0	1260	1230
20	14	250	1.03	.82	35.0	8.0	16.0	1320	1290
20	16	250	1.03	.89	35.0	8.0	16.0	1375	1345
20	18	250	1.03	.96	35.0	8.0	16.0	1445	1415
20	20	250	1.03	1.03	35.0	8.0	16.0	1525	1495
24	12	250	1.16	.75	31.5	0.5	8.5	1285	1245
24	14	250	1.16	.82	40.5	9.0	17.0	1865	1825
24	16	250	1.16	.89	40.5	9.0	17.0	1925	1885
24	18	250	1.16	.96	40.5	9.0	17.0	1990	1950
24	20	250	1.16	1.03	40.5	9.0	17.0	2070	2030
24	24	250	1.16	1.16	40.5	9.0	17.0	2245	2205
30	12	250	1.37	.75	49.0	10.0	18.0	1900	1890
30	16	250	1.37	1.00	49.0	10.0	18.0	3105	2995
30	18	250	1.37	1.06	49.0	10.0	18.0	3175	3070
30	20	250	1.37	1.13	49.0	10.0	18.0	3235	3150
30	24	250	1.37	1.25	49.0	10.0	18.0	3425	3315
30	30	250	1.37	1.37	49.0	10.0	18.0	2372	3630

MECHANICAL JOINT-DUCTILE IRON FITTINGS

FULL BODY FITTINGS

ANSI/AWWA-C110/A21.11 Standards

OFFSETS

For use With Push-on Joint Pipe,
Mechanical Joint Pipe Or Any Plain End
Pipe of Same Outside Diameter

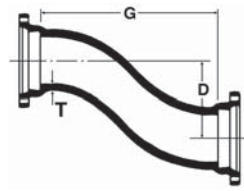

Offset
MJ and MJ

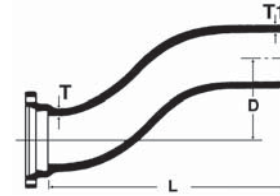

Offset
MJ and PE

DIMENSIONS AND WEIGHTS

Nominal Diameter By Offset Inches	Pressure Rating psi	Dimensions Inches					Weight Pounds Body Casting Only Approximate	
		Ductile	T	T1	D	G	L	MJ and MJ
4 x 6	350	.52	.47	6	19	27	...	70
4 x 12	350	.52	.47	12	22	30	85	80
4 x 18	350	.52	.47	18	30	38	105	...
4 x 24	350	.52	.47	24	23.50	31.50	125	115
6 x 6	350	.55	.50	6	20	28	110	105
6 x 12	350	.55	.50	12	26	34	135	130
6 x 18	350	.55	.50	18	33	41	165	160
6 x 24	350	.55	.50	24	22.25	30.25	165	165
8 x 6	350	.60	.54	6	21	29	160	155
8 x 12	350	.60	.54	12	28	36	200	195
8 x 18	350	.60	.54	18	35	43	245	240
8 x 24	350	.60	.54	24	38.25	46.25	280	275
10 x 12	350	.68	.60	12	30	38	280	280
10 x 18	350	.68	.60	18	38	46	340	340
10 x 24	350	.68	.60	24	38	46	420	...
12 x 12	350	.75	.68	12	37	45	420	420
12 x 18	350	.75	.68	18	48	56	520	520
12 x 24	350	.75	.68	24	48	56	640	630
16 x 12	350	.70	.70	12	40	48	715	...
16 x 18	350	.70	.70	18	50	58	850	830
20 x 12	350	.70	.70	12	40	48	1025	...
20 x 18	350	.70	.70	18	48	60	1275	...

Clearance Required for Ratchet Wrench between Two Mechanical Joint

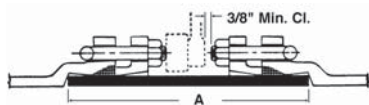

Mechanical Joint to Mechanical Joint

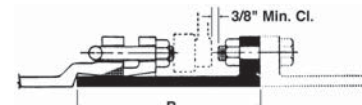

Mechanical Joint to Flanged Joint

Minimum Length of Connectors Which Can be Used ††

Pipe Size Inches	"A" = min. Length Inches	"B" = min. Length Inches
3	12.00	9.00
4	12.75	9.75
6	12.75	10.00
8	13.50	10.50
10	13.50	10.75
12	13.25	10.50
14	15.25	11.75
16	16.00	12.50
18	16.00	12.50
20	16.00	12.75
24	16.50	13.50
30	17.50	11.75

†† If open end wrenches are used, overall lengths "A" and "B" may be reduced by 2 1/4 inches.



2" - 36" MECHANICAL JOINT - DUCTILE IRON FULL BODY FITTINGS

ANSI/AWWA-C110/A21.10 and ANSI/AWWA-C111/A21.11 Standards

PLUGS



Solid or Tapped

Size	Tap	Weight	
		Solid	Tapped
*2	2	5	5
3	3	10	10
4	3	15	15
6	3	25	25
8	4	45	45
10	4	65	65
12	4	85	85
14	4	120	120
16	4	150	150
†18	4	180	180
†20	4	200	200
†24	4	290	290
†30	4	575	575
†36	4	815	...

†Dished - Not flat as shown.
* Not included in AWWA C110

CAPS



Solid or Tapped

Size	Tap	Weight	
		Solid	Tapped
*2	2	5	...
3	3	12	12
4	3	20	20
6	3	30	30
8	4	45	45
10	4	60	60
12	4	80	80
14	4	110	110
16	4	150	150
†18	4	185	185
†20	4	250	250
†24	4	300	300
†30	4	590	590
†36	4	850	850

† Dished - Not flat as shown.
* Not included in AWWA C110.

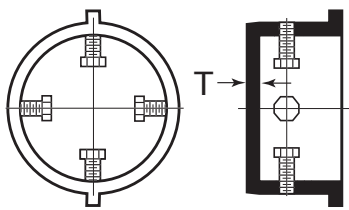

TYTON® Plug**

Size	T	Weight*
4	.60	18
6	.65	25
8	.70	46
10	.75	70
12	.75	95

* Weights do not include accessories
** Not included in AWWA C110.

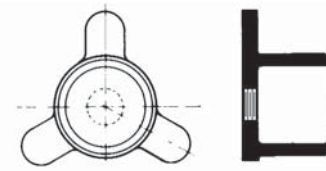

Solid Tapped
***Push-In Plug with Ears**
(To be used with all push-on ductile iron pipe and fittings)

Size	Tap	Weight
14	2.0	110
16	2.0	145
18	2.0	180
†20	2.0	220
†24	2.0	315

† Dished - Not flat as shown
NOTE: Blocking still required-ears for assembly only.

PUSH-ON PLUGS AND TEST PLUGS

For Use With PUSH-ON Joint Ductile Iron Pipe Per AWWA C111 spec.

PUSH-ON UNRESTRAINED PLUG



Solid Plug



Push-on Plug Installed



Plug Tapped

Size Inches	Maximum Tap Size Inches	Size, Vent Connection Inches	Size, Press. Connection Inches	Approximate Weight Pounds
4	3	1/4	1/2	10
6	4	1/4	3/4	18
8	4	1/4	3/4	33
10	4	1/4	3/4	53
12	4	1/4	3/4	75
14	4	1/4	3/4	110
16	4	1/4	3/4	145
18	4	1/4	3/4	180
20	4	1/4	3/4	220
24	4	1/4	3/4	315
30	4	1/4	3/4	545

PUSH-ON RESTRAINED PLUG

Note: The Test Plug is the same as the Solid Plug, except for tapping, nipple and petcock.

Regularly furnished with cadmium plated stud bolts.

Instruction Tags are shipped with each plug.



Test Plug



Solid Plug

Description and Installation

Retainer wedges have leading edge contour conforming to inside lip of Push-on Bell and with taper on trailing edge to match taper of back-up lug on plug. Wedges are of ductile iron.

In installation, tightening hold down nuts force retaining wedge under lip of the bell because of the trailing edge against the tapered lug on the plug, and securely holds dogs in this position.

The gasket is only slightly displaced, and the seal is not affected.

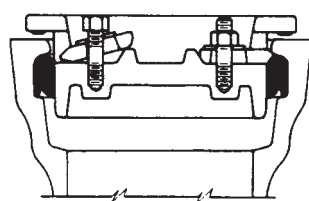

Section Showing Plug Installed In Bell*

PLUG

Size Inches	Maximum Test Pressure PSI	Size, Vent Connection Inches	Size, Pressure Connection Inches	Number of Retaining Lugs	Number of Stud Bolts	Approximate Weight Pounds
4	250	1/4	1/2	2	2	10
6	250	1/4	3/4	3	3	18
8	250	1/4	3/4	3	3	29
10	150	1/4	3/4	3	3	44
12	150	1/4	3/4	3	3	59

Note: Test plugs are shipped complete with 1/4" x 6" nipple and brass petcock, except 3" plugs which have 1/8" x 6".

All Push-On plugs are normally furnished without gaskets.

MECHANICAL JOINT TEST PLUGS

Easily Installed—Easily Removed—Only A Ratchet Wrench Needed (AWWA C111)
No Leading or Calking Required.

Note: Bolts and Gasket Will be Furnished Only When So Ordered

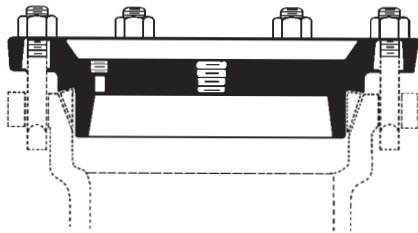

Section



Test Plug

For Bell Ends of Mechanical Joint Pipe and Fittings

Size Inches	Size, vent connection Inches	Size, pressure connection Inches	Number of bolt holes	Maximum test pressure psi	Approximate weight Pounds
3	1/4	3/4	4	250	12
4	1/4	3/4	4	250	20
6	1/4	3/4	6	250	30
8	1/4	3/4	6	250	50
10	1/4	3/4	8	250	65
12	1/4	3/4	8	250	85

Sizes 8-inch and smaller have two vent openings—one on and the other straddling the centerline of bolt holes in the plug—so that a vent can be placed at the top of the line being tested. For sizes larger than 12-inch, our Solid Plug can be arranged for use as a test plug.

SUPER- LOCK PLUGS

(Not Illustrated)

Tapped Plug, Test Plug, Super-Lock Plugs are Ductile Iron Rated for 350 PSI Working Pressure (AWWA C111)



Section Showing Plug Installed in Bell

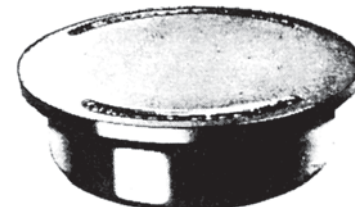

Solid Plug

DIMENSIONS AND WEIGHTS

Size Inches	Weight of Plug pounds	Weight of Retainer pounds
6	17	20
8	27	30
10	45	40
12	60	55
14	85	80
16	110	95
18	145	135
20	185	160
24	270	275
30	510	460

For Bell Ends of Super-Lock Pipe or Fittings.

Note: Retainer, Retainer Lock, and Roll Pin furnished with plug. Super-Lock push-on plugs normally furnished without gaskets. Test plugs shipped complete with 1/4" X 6" nipple and brass petcock. Maximum tap size is 4 inches for plugs.

**2" - 36" MECHANICAL JOINT - DUCTILE IRON
FULL BODY FITTINGS**

ANSI/AWWA-C111/A21.10 and ANSI/AWWA-C111/A21.11 Standards

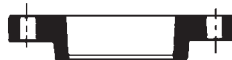
MJ GLAND ONLY

Size	Gland Pack Wt.	Weight Gland Only
2	5	4
3	7	5
4	10	6
6	16	11
8	25	18
10	30	20
12	40	30
14	45	35
16	55	45
18	65	55
20	85	70
24	105	90
30	220	180
36	301	248



MECHANICAL JOINT ANCHORING FITTINGS

MJ Connections per AWWA C111

FOR HYDRANT LEADS, BRANCH LINE STUBS, DEAD-ENDS AND OTHER INSTALLATIONS WHERE POSITIVE ANCHORING IS REQUIRED CAN BE DISASSEMBLED IN THE FIELD

Clow Anchoring Fittings are “plain end” mechanical joint fittings with an integral follower gland. The protruding plain end, when fitted with gasket, is inserted into a standardized mechanical joint bell, and bolted tight, flange to flange. These fittings eliminate the need for tie rods and other costly, time-consuming methods of positive, fixed placement. When used with shut-off valves, these fittings prevent the valve from blowing-off and eliminate the need for blocking. They save time and labor in installation, and save digging when a hydrant must be moved or replaced. They are desirable in hydrant leads for anchoring the auxiliary valve either at the hydrant or at the tee in the main. They can be used with a shut-off valve in place of a plug in a tee to permit extending the line during construction without interrupting testing; and/or at the stub end of a line, either branch or main line, to eliminate blocking and the possibility of blow-off. Fittings include couplings, pipe, tees and elbows.

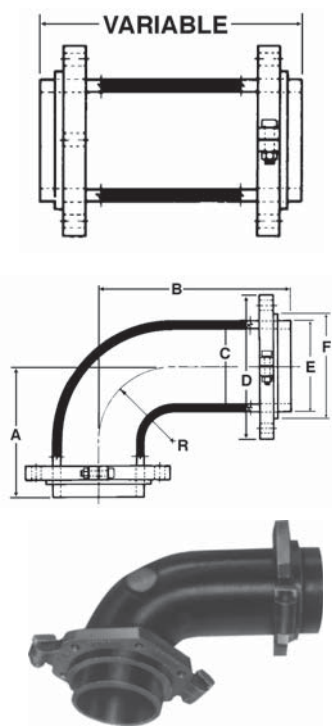

ADAPTERS Swivel x Solid Adapter

Size by Laying Length	Wall Thickness	Weight*
4x13	.52	61
6x12	.55	42
6x18	.55	58
6x24	.55	100
6x36	.55	129
8x12	.60	70
12x13	.75	173

*Weights with Gland.

ELBOWS 90° Swivel x Swivel Ell (Not Included In AWWA C110)

Size	Wall Thickness	Dimensions							*Weight
		A	B	C	D	E	F	R	
6	.55	10.5	15.5	7.10	11.12	6.90	8.02	6.0	100
8	.60	11.5	16.5	9.20	13.37	9.05	10.17	7.0	140

*With 2 Swivel Glands

ANCHOR PIPE WITH WELD RING

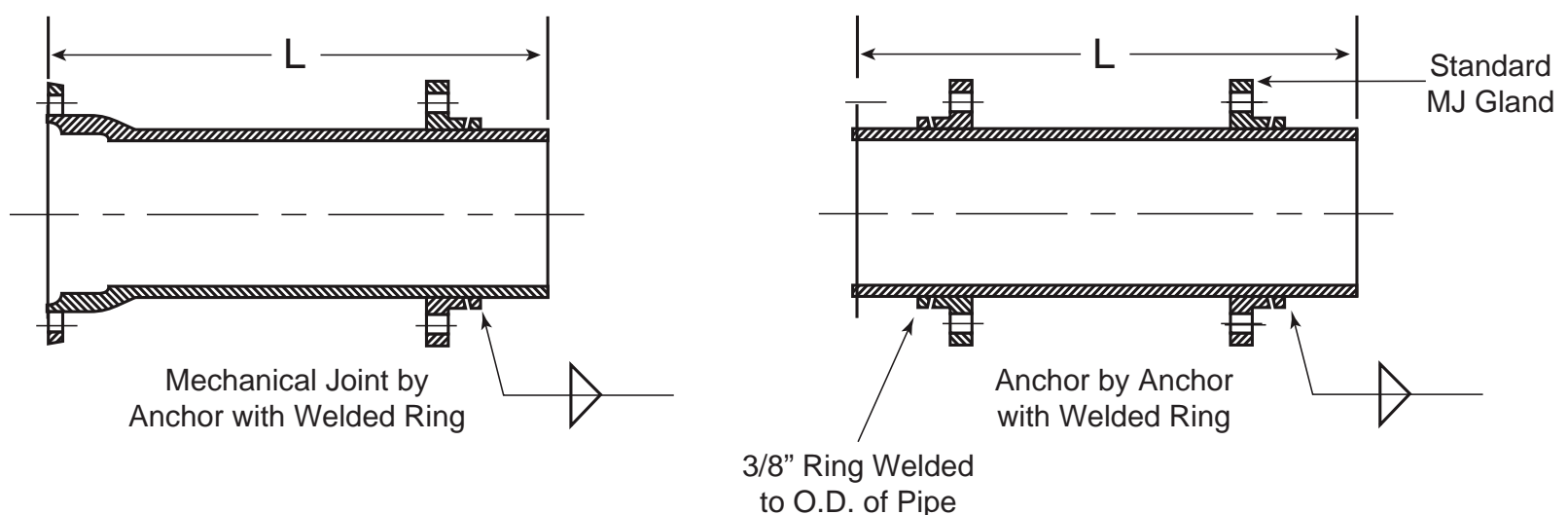

Notes:

1. Tolerance on length of pipe shall be 0.25”.
2. Above materials shall meet all applicable sections of ANSI A21.10, A21.15, A21.50, A21.51, B2.1, B16.1, AWWA C110, C115, C150, C151, and all revisions thereto.
3. Anchor pipe shall be made of Ductile-Iron pipe class 53.
4. Lining shall be in accordance with ANSI A21.4.
5. Pusher gland ANSI/AWWA A21.10/C110, A21.53/C153.
6. Size normally 6” - however, available in 4” - 6” - 8” - 12”.
7. Length - As required.
8. Requires longer thread bolts.

MECHANICAL JOINT DUCTILE IRON ANCHORING FITTINGS

MJ Connections per AWWA C111

TEES—ELBOWS

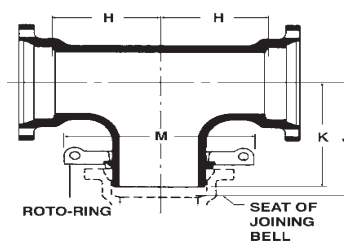

Anchoring Tee, Mechanical Joint

DIMENSIONS AND WEIGHTS

Pipe Size Inches	Dimensions				Weight in pounds
	H	K	J	M	Anchoring Tee†
6 x 6	8	10.5	10.75	14.25	116
8 x 6	9	11.5	11.75	14.25	165
8 x 8	9	11.5	11.75	16.50	198
10 x 6	11	13.5	13.75	14.25	270
10 x 8	11	13	13.75	16.50	285
12 x 6	12	14.5	14.75	14.25	345
12 x 8	12	14	14.75	16.50	360
14 x 6	14	16.5	16.75	14.25	500
14 x 8	14	16	16.75	16.50	455
16 x 6	15	17.5	17.75	14.25	619
16 x 8	15	17	17.75	16.50	560
18 x 6	13	17.5	18.25	14.25	750
18 x 8	13	17.5	18.25	16.50	610
20 x 6	14	19.5	19.75	14.25	829
20 x 8	14	19	19.75	16.50	740
24 x 6	15	21.5	21.75	14.25	1134
24 x 8	15	21	21.75	16.50	1000
30 x 6	18	24.5	25.75	14.25	1739
30 x 8	18	25	25.75	16.50	1750

† Does not include MJ accessories.

Anchoring Tees and Elbows

The anchoring tee is a standard MJ tee except that the branch is plain end with an integral gland and split Roto-Ring. The RotoRing anchors the plain end to any MJ bell attached to the branch. This tee can be used for hydrant leads and for anchoring a valve to a tee when a future branch line is anticipated.

The anchoring elbow is really three fittings in one—two anchoring couplings plus one 90° elbow. It allows hydrants to be anchored at either of two distances parallel to the main. For example, when bolted to a 6" x 6" standard MJ tee, it anchors the hydrant on either 19" or 24" centers from the main line.

* Branch sockets with standardized MJ bell only.

Some Typical Installations using MJ Anchoring Fittings

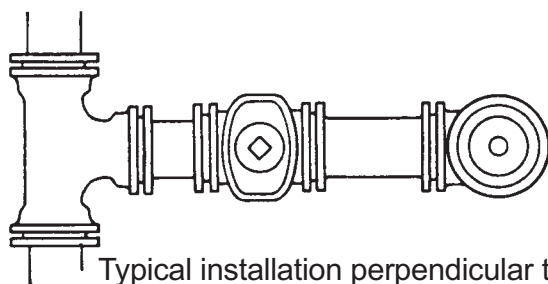

Typical installation perpendicular to the main using standard MJ tee, Coupling, MJ valve, Pipe, and MJ Hydrant.

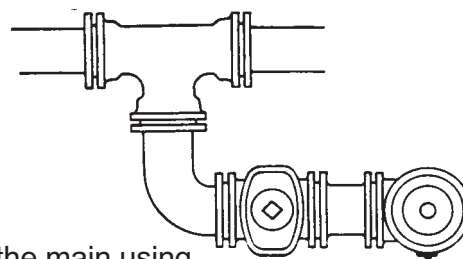

Typical installation parallel to the main, using standard MJ tee, Elbow, MJ valve, Coupling, and MJ Hydrant.

Typical installation of hydrant perpendicular to the main, using Anchoring Tee, MJ Valve, Pipe and MJ Hydrant.

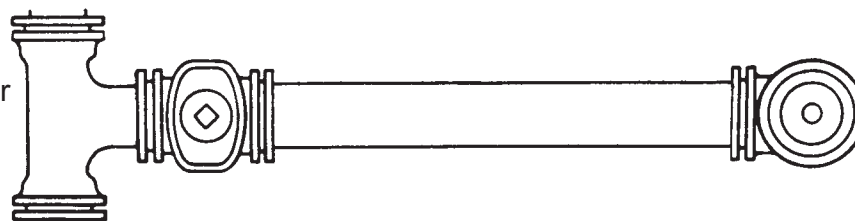



2" - 36" MECHANICAL JOINT - DUCTILE IRON FULL BODY FITTINGS

Manufactured in Accordance With
ANSI/AWWA C-110/A21.10

SWIVEL GLAND ASSEMBLY

Used with swivel fittings, the CLOW Swivel Gland, with its rotating feature, permits the installer to meet any grade requirements regardless of bolt-hole alignment. In addition, the system permits stiff connections without braces, blocking or strapping.

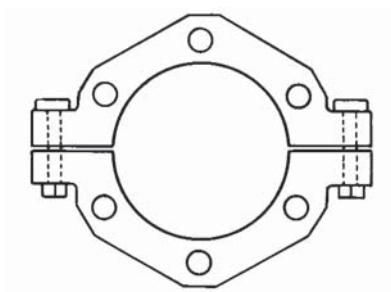

Swivel Glands**

Size	Weight
4	9
6	16
8	24
12	33

** Not included in AWWA C110.

NOTE: When ordering glands separately,
(1) Description, and
(2) Size of fitting to be joined.

MECHANICAL JOINT HYDRANT TEES

MJ Connections per AWWA C111

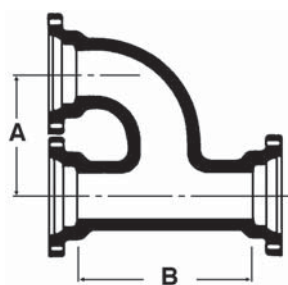

MJ Hydrant Tee

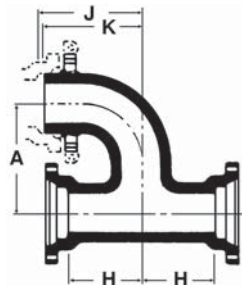

MJ Hydrant Tee
Anchoing on the Branch

Hydrant tees are a combination tees and 90° elbow for use in hydrant installations where space is limited. Their unique design keeps the hydrant close to the main line, and permits the hydrant to be installed in the same trench, saving digging costs. Because it has one less joint than two fittings, it also saves time and labor in assembly. Since it is an integral unit, it anchors the hydrant to the main, and locates the hydrant a uniform distance from the main.

DIMENSIONS AND WEIGHTS

Nominal Diameter Inches	Dimensions Inches					Approximate Weight Pounds	
	A	B	H	J	K	MJ Hydrant Tee	MJ Hydrant Tee Anchoing on the Branch
6 x 6	12 1/2	16	8	10 3/4	10	170	175
8 x 8	13 1/2	18	9	11 3/4	11	215	220
10 x 6	14	22	11	13 3/4	13	275	280
12 x 6	16	24	12	14 3/4	14	375	380

* Includes weight of Anchoing Gland, which is made on at the factory. Anchoing branch socket with standardized MJ Bell only.

MECHANICAL JOINT DUCTILE IRON BASE BENDS AND BASE TEES

ANSI/AWWA-C110/A21.10 and ANSI/AWWA-C111/A21.11 Standards

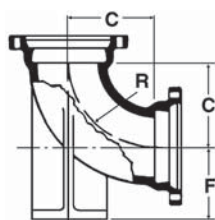

90° Base Bend
MJ and MJ

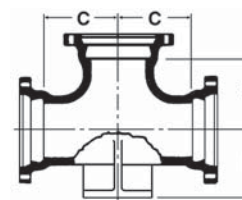

Base Tee
MJ, MJ, and MJ

DIMENSIONS AND WEIGHTS

Nominal Diameter Inches	Pressure Rating psi	Dimensions Inches				Approximate Weight—Pounds Body Casting with Base Only		
		Ductile	B	C	F †	R	MJ and MJ	MJ, MJ and MJ
3	350		5.5	5.5	4.88	4.0	45	60
4	350		6.5	6.5	5.50	4.5	65	90
6	350		8.0	8.0	7.00	6.0	105	140
8	350		9.0	9.0	8.38	7.0	165	215
10	350		11.0	11.0	9.75	9.0	235	340
12	350		12.0	12.0	11.25	10.0	320	455
14	350		14.0	14.0	12.50	11.5	410	635
16	350		15.0	15.0	13.75	12.5	505	790
18	350		16.5	16.5	15.00	14.0	660	895**
20	350		18.0	18.0	16.00	15.5	800	1095**
24	350		22.0	22.0	18.50	18.5	1155	1615**

The pressure rating of the Flange and MJ Base Bend is limited to 250 psi by the flanged joint.

† Dimensions "F" are for machined bases. For bases not machined, add approximately 1/8 inch.

**Body casting and base only—accessories not included.

Bases will be machined and/or drilled ONLY when so ordered.

BASE TEES REDUCING ON BRANCH

To compute the total weight of tees reducing on the branch, add weight of the Base Only (see page 68) to the weight of reducing tee wanted (see pages 33-35).